

## Physical Accessibility Review Survey

California Department of Health Care Services  
Medi-Cal Managed Care Division

Provider Name: <input type="checkbox"/> PCP <input type="checkbox"/> Specialist <input type="checkbox"/> Ancillary	Date of Review:
Address:	Name of Reviewer:
City:	Health Plan Name:
Phone: <span style="float: right;">FAX:</span>	Contact Person Name:
	<b><i>Level of Access:</i></b>
<b><u>Basic Access:</u></b> Demonstrates facility site access for the members with disabilities to parking, building, elevator, doctor's office, exam room and restroom. To meet Basic Access requirements, all (29) Critical Elements (CE) must be met.	<input type="checkbox"/> Basic Access
<b><u>Limited Access:</u></b> Demonstrates facility site access for the members with a disability is missing or is incomplete in one or more features for parking, building, elevator, doctor's office, exam room, and restroom. Deficiencies in 1 or more of the Critical Elements (CE) are encountered.	<input type="checkbox"/> Limited Access
<b><u>Medical Equipment Access:</u></b> PCP site has height adjustable exam table and patient accessible weight scales per guidelines (for wheelchair/scooter plus patient). This is noted in addition to level of Basic or Limited Access as appropriate.	<input type="checkbox"/> Medical Equipment is available

Below are the symbols that will be used in the provider directories to indicate areas of accessibility at a provider office/site. These should also be used in online directories. In order for a provider office to receive a symbol, the appropriate criteria must be met.

These symbols are in addition to identifying whether the provider office has Basic Access or Limited Access. A provider who has Basic Access will automatically meet the critical elements for the first six symbols (P, EB, IB, R, and E). And a provider who has Medical Equipment Access will meet the medical equipment elements for the last symbol (T).

<b>Accessibility Indicator</b>	<b>Must Satisfy these Criteria</b>	<b>Yes</b>	<b>No</b>	<b>N/A</b>	<b>Comments</b>
<b>P = PARKING</b>	Critical Elements (CE): 3, 7, 8, 11				
<b>EB - EXTERIOR BUILDING</b>	(CE): 14, 20, 22, 23 25, 27, 28, 31				
<b>IB = INTERIOR BUILDING</b>	(CE): 31, 34, 37 If lift include: 40 If elevators include: 53, 54, 55, 56, 57, 58				
<b>R=RESTROOM</b>	(CE): 65, 67, 68, 71, 75, 77				
<b>E=EXAM ROOM</b>	(CE): 80, 85				
<b>T = EXAM TABLE/SCALE</b>	Medical Equipment Elements (ME): 81, 82, 86				

I certify that there have been no changes since the last physical accessibility review:

Name: \_\_\_\_\_ Signature: \_\_\_\_\_ Date: \_\_\_\_\_

I certify that there have been no changes since the last physical accessibility review:

Name: \_\_\_\_\_ Signature: \_\_\_\_\_ Date: \_\_\_\_\_

Question #	Criteria (CE = Critical Elements)	Explanation/Guidelines	Yes	No	N/A	Comments
------------	--------------------------------------	------------------------	-----	----	-----	----------

**PARKING**

1	Is off-street public parking available?	Self explanatory.				
2	Are accessible parking spaces provided in off-street parking?	Self explanatory.				
3 (CE)	<b>Are the correct number of accessible parking spaces provided?</b> <b>1 to 25 total spaces - 1 required</b> <b>26 to 50 - 2 required</b> <b>51 to 75 - 3 required</b> <b>76 to 100 - 4 required</b> <b>101 to 150 - 5 required</b> <b>151 to 200 - 6 required</b> <b>201 to 300 - 7 required</b> <b>301 to 400 - 8 required</b>	If there are 25 total parking spaces or less, at least one accessible space is required. If there are between 26 and 50 total spaces, at least two accessible spaces are required, etc.				

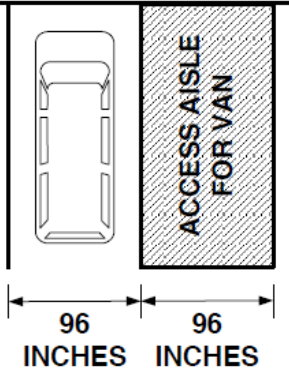
Question #	Criteria (CE = Critical Elements)	Explanation/Guidelines	Yes	No	N/A	Comments
4	Is the accessible parking space(s) closest to the main entrance?	The accessible parking space (s) should afford the shortest route of travel from adjacent parking to the accessible entrance.				
5	Is there an access aisle next to the accessible space(s)?	<p>The access aisle is the space next to the accessible parking space where a person using the accessible space can load and unload from the vehicle.</p> 				
6	Is the parking space(s) and access aisle(s) free of curb ramps that extend into the space and other obstructions?	If a curb ramp extends into the parking space(s) or access aisle, a person using that space and aisle would not have adequate level space to unload and load from the vehicle.				

Question #	Criteria (CE = Critical Elements)	Explanation/Guidelines	Yes	No	N/A	Comments
7 (CE)	<b>Do curbs on the route from off-street public parking have curb ramps at the parking locations?</b>	Pathways should have curb ramps. Without curb ramps, wheelchair users may be required to travel in the street or behind parked cars where drivers cannot see them.				
8 (CE)	<b>Do curbs on the route from off-street public parking have curb ramps at the drop off locations?</b>	See above Question # 7.				
9	Does every accessible parking space have a vertical sign posted with the International Symbol of Accessibility?	<p>Symbol in the illustration depicts the International Symbol of Accessibility.</p> 				

Question #	Criteria (CE = Critical Elements)	Explanation/Guidelines	Yes	No	N/A	Comments
10	Are signs mounted a minimum of 60 inches above the ground surface so that they can be seen over a parked vehicle?	Signs must be located so a vehicle parked in the space does not obscure them. (Van accessible spaces must be indicated with an additional sign)				
11 (CE)	<b>Is VAN accessible parking provided?</b>	1 van space for every 6 standard accessible spaces must be provided, but never less than one. For example, if there are 23 total spaces, at least one accessible space is required and it must be large enough (See Question # 5 for dimensions) to accommodate a van. If there are 201 total parking spaces, at least seven accessible spaces would be required and two of those would have to accommodate vans.				
12	Is VAN accessible parking signage provided?	Signs must be mounted a minimum of 60 inches above the ground surface so that they can be seen over a parked vehicle.				

Question #	Criteria (CE = Critical Elements)	Explanation/Guidelines	Yes	No	N/A	Comments
------------	-----------------------------------	------------------------	-----	----	-----	----------

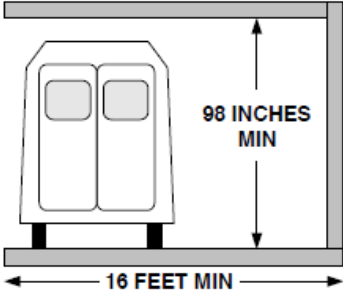
13	<p>If van accessible parking is provided in a parking garage, is there at least 8 feet 2 inches (98 inches total) vertical clearance available for full-sized, lift equipped vans?</p>	<p>If there is no parking garage, check NA.</p> <p>If designated accessible parking is located in a garage, the vertical clearance should be at a minimum 8 feet 2 inches (98 inches). Vertical clearance should be posted.</p> 				
----	--	--	--	--	--	--

**EXTERIOR ROUTE (FROM ACCESSIBLE PARKING, PUBLIC TRANSPORTATION, AND PUBLIC SIDEWALK TO THE ENTRANCE)**

14 (CE)	<p>For exterior routes, if the accessible route crosses a curb, is a curb ramp provided to the building entrance from the following: (Please mark NA for those that do not apply.)</p>	Self explanatory.				
	a. Parking?					
	b. Public transportation?					

Question #	Criteria (CE = Critical Elements)	Explanation/Guidelines	Yes	No	N/A	Comments
------------	-----------------------------------	------------------------	-----	----	-----	----------

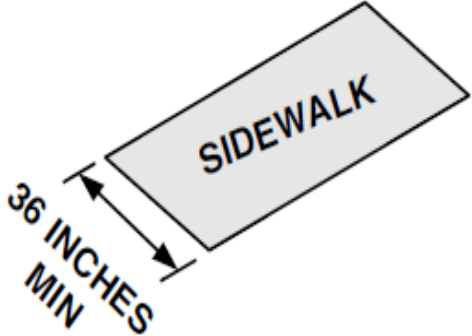
	c. Public sidewalk?					
15	Is the accessible route to the building entrance at least 36 inches wide for exterior routes from the following: (Please mark NA for those that do not apply.)					
	a. Parking?					
	b. Public transportation?					
	c. Public sidewalk?					
16	Is the accessible route to the building entrance stable, firm, and slip resistant from the following: (Please mark NA for those that do not apply.)	<p>An example of a stable surface is a floor or ground surface without loose elements like gravel or wood chips.</p> <p>Firm surfaces include solid concrete or pavement as opposed to a grassy, graveled or soft soil surface.</p> <p>Avoid glossy or slick surfaces such as ceramic tile.</p>				
	a. Parking?					

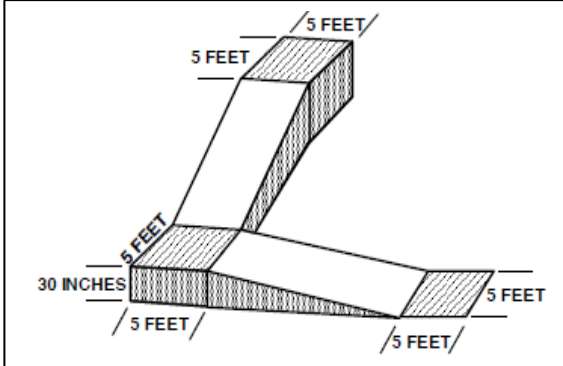

Question #	Criteria (CE = Critical Elements)	Explanation/Guidelines	Yes	No	N/A	Comments
	b. Public transportation?					
	c. Public sidewalk?					
17	Is there an accessible route that does not include stairs or steps?	Self explanatory.				
18	Is the route to the entrance from the accessible parking spaces, including transitions at curb ramps, free of grates, gaps, and openings that are both greater than ½ inch wide and over ¼ inch deep?	Self explanatory.				
<b>RAMPS:</b>						
19	Is an access ramp present?	If there is more than one ramp, select the one that appears to be the primary access ramp.				

Question #	Criteria (CE = Critical Elements)	Explanation/Guidelines	Yes	No	N/A	Comments
20 (CE)	Is each run (leg) of the ramp no longer than 30 feet between landings?	<p>Each "run," shown in the white sections in the diagram below, must be no longer than 30 feet.</p> 				
21	Are 60 inches (5 feet) long, level landings provided at the top and bottom of each ramp run?	See Question 20 diagram above.				

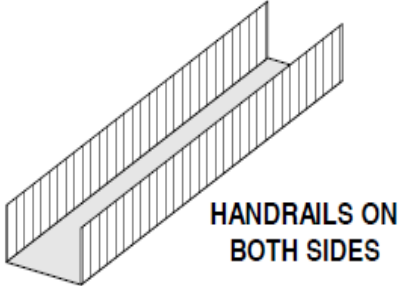
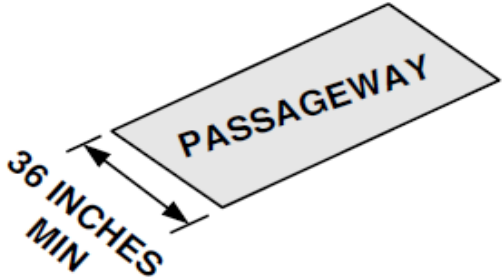
Question #	Criteria (CE = Critical Elements)	Explanation/Guidelines	Yes	No	N/A	Comments
22 (CE)	Are handrails provided on both sides of the ramp that are mounted between 34 and 38 inches above the ramp surface, if it is longer than 6 feet?	<p>If the ramp is not longer than 6 feet, check NA.</p> 				
23 (CE)	Are all ramps at least 36 inches wide?					

Question #	Criteria (CE = Critical Elements)	Explanation/Guidelines	Yes	No	N/A	Comments
------------	--------------------------------------	------------------------	-----	----	-----	----------

**BUILDING ENTRANCE**

24	Is the main entrance accessible?	Self explanatory.				
25 (CE)	<b>If a main entrance is not accessible, is there another accessible entrance?</b>	Self explanatory.				
26	If a main entrance is not accessible, is there directional signage indicating the location of the accessible entrance?					

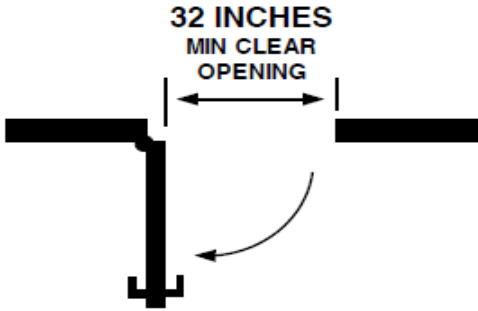
Question #	Criteria (CE = Critical Elements)	Explanation/Guidelines	Yes	No	N/A	Comments
27 (CE)	Do doors have an opening at least 32 inches wide (at the narrowest point below the opening hardware) when opened to 90°?	<p>When measuring double doors, measure the opening with one door open to 90°.</p> 				
28 (CE)	Is space available for a wheelchair user to approach, maneuver, and open the door?	<p>Appropriate space perpendicular and parallel to a doorway permits a wheelchair user, people using walkers and other mobility devices to open the door safely and independently. Following are two common examples of required minimum maneuvering clearances:</p> <ol style="list-style-type: none"> <li>1. Approaching the door and pulling it toward you to open requires 60 inches of clear space perpendicular to the doorway and 18 inches parallel to the doorway.</li> <li>2. Approaching the door and pushing it away from you to open requires 48 inches of clear space perpendicular to the doorway.</li> </ol>				

Question #	Criteria (CE = Critical Elements)	Explanation/Guidelines	Yes	No	N/A	Comments
------------	-----------------------------------	------------------------	-----	----	-----	----------

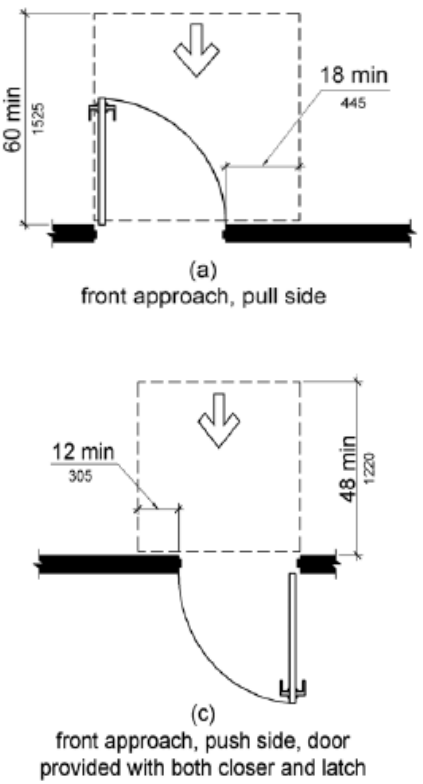
		 <p>(a) front approach, pull side</p> <p>(c) front approach, push side, door provided with both closer and latch</p>				
--	--	---	--	--	--	--

29	Is the space required to open the door level and clear of movable objects (chairs, trash cans, etc.)?	If there are nonpermanent items such as trash cans, merchandise, etc., located in these areas, they must be removed or relocated.				
----	---	---	--	--	--	--

Question #	Criteria (CE = Critical Elements)	Explanation/Guidelines	Yes	No	N/A	Comments
30	Are there automatic doors?	Self explanatory.				
31 (CE)	<b>Do entrance doors have handles that can be opened without grasping, pinching, or twisting of the wrist?</b>	Can the door be opened by someone with a closed fist or fully open hand? Door knobs, for example, cannot be used in this manner.				
<b>INTERIOR ROUTE (FROM THE BUILDING ENTRANCE TO THE CLINIC/OFFICE ENTRANCE, TO THE REGISTRATION COUNTER/WINDOW, AND THROUGH THE CLINIC/OFFICE TO AREAS THAT PATIENTS COULD GO)</b>						
32	Is there an interior route to the medical office?	Some medical offices are accessed directly from the street or parking lot rather than being located within a larger office building or complex, therefore they do not have interior routes.				

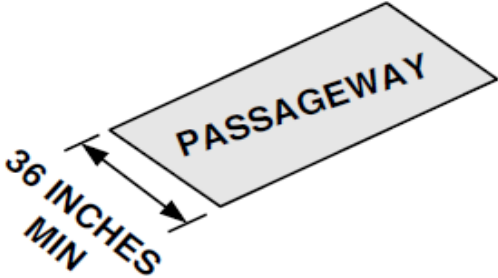
Question #	Criteria (CE = Critical Elements)	Explanation/Guidelines	Yes	No	N/A	Comments
33	Is there an interior accessible route to the medical office that does not include stairs or steps?	Floors of a given story are level throughout the building, or connected by ramps, passenger elevators or access lifts.				
34 (CE)	Are <u>ALL</u> interior paths of travel at least 36 inches wide?					
35	Is the interior accessible route stable, firm, and slip resistant?	<p>Avoid unsecured carpeting or other loose elements.</p> <p>It is easier for people using walkers, wheelchairs and other aids to walk or push on surfaces that have low pile carpeting without a pad underneath.</p> <p>Glossy or slick surfaces such as ceramic tile or marble can be slippery.</p>				
36	Is the interior accessible route well lighted?	A brightly lit corridor will help avoid falls.				

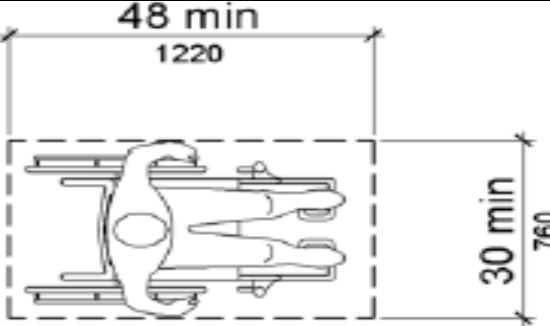
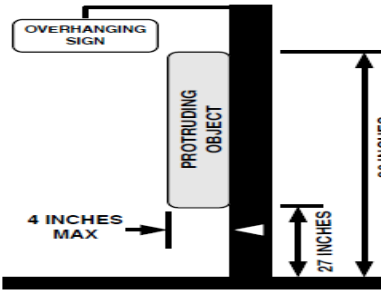

Question #	Criteria (CE = Critical Elements)	Explanation/Guidelines	Yes	No	N/A	Comments
37 (CE)	If there are stairs on the accessible route, are there handrails on each side?	If there are no stairs, check NA.				
38	If there are stairs, are all stairs risers closed that are on the accessible route?					
39	If there are stairs, are all stair treads marked by a stripe providing a clear visual contrast to assist people with visual impairments?	Contrast striping must be provided on the upper approach and lower tread for interior stairs and on the upper approach and all treads for exterior stairs. Stripes must be 2" to 4" wide placed parallel to and no more than 1" from the nose of the step or upper approach. The stripe must extend the full width of the step or upper approach and should be made of material that is at least as slip resistant as the other stair treads (a painted stripe is acceptable).				
40 (CE)	If a platform lift is used, can it be used without assistance?	<p>If there is no platform lift, check NA.</p> <p>Lifts sometimes require a key for operation, thus preventing independent use.</p>				

Question #	Criteria (CE = Critical Elements)	Explanation/Guidelines	Yes	No	N/A	Comments
41	Does the interior door to the medical office require less than 5 pounds of pressure to open?	<p>If interior door is a fire door, check NA.</p> <p>For interior doors (not fire doors), labor force to open a door should be <math>\leq 5</math> lbs. Measure the weight of the labor force of the door after the door is unlatched; attach the hook end of the scale to the door handle and pull until the door opens and read the weight of the force.</p>				
42	Is there a clear space 30 inches wide by 48 inches long in the waiting area(s) for a wheelchair or scooter user to park that is not in the path of travel?					
43	Is the path through the medical office free of any objects that stick out into the circulation path that a blind person might not detect with a cane?	<p>If an object protrudes more than 4 inches and is located between 27 inches above the walking surface and below 80 inches, a blind person walking with a cane will not detect it.</p> 				

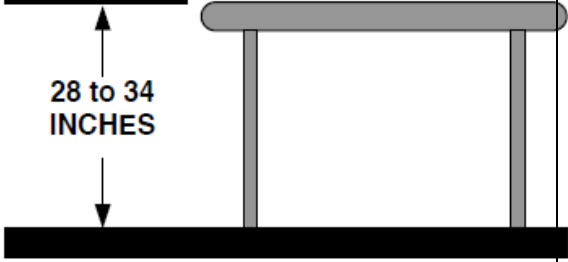
Question #	Criteria (CE = Critical Elements)	Explanation/Guidelines	Yes	No	N/A	Comments
44	If floor mats are used, are the edges of floor mats stiff enough or secured so that they do not roll up?	<p>If floor mats are not in use, check NA.</p> <p>Floor mats that are not secured to the floor can roll up or bunch up under walkers or wheelchair casters and cause a tripping hazard.</p>				
45	Is a section of the sign-in/registration counter no more than 34 inches high and at least 36 inches wide and free of stored items.	 <p>The diagram shows a side view of a counter. A horizontal line at the top represents the counter's surface. A vertical double-headed arrow indicates the height from the floor to this surface, labeled '28 to 34 INCHES'. The counter is supported by two vertical legs. The counter top is shaded gray, and the floor is represented by a thick black horizontal bar at the bottom.</p>				
46	Does the office have a method, other than a lowered counter, by which people can sign in/register? (If yes, please note this method in comments.)	A medical office may use reasonable alternative methods to meet this need such as a clip board.				

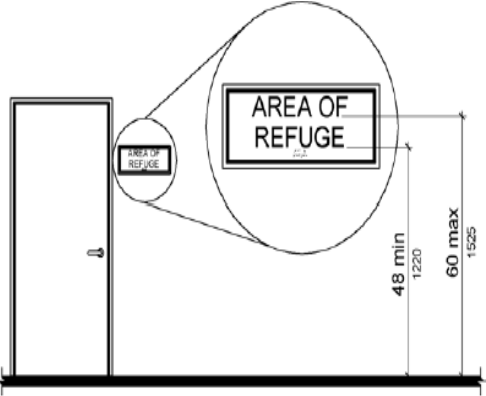
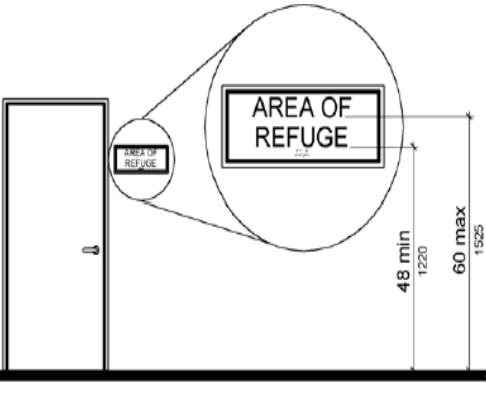
Question #	Criteria (CE = Critical Elements)	Explanation/Guidelines	Yes	No	N/A	Comments
47	Do signs identifying permanent rooms and spaces include raised letters and Braille?					
48	Are the raised letters and Braille signs mounted between 48 inches and 60 inches from the floor?	 <p data-bbox="667 1209 1207 1339">Raised letters and Braille signs are either on the latch side of doors or on the face of doors and are mounted between 48 inches and 60 inches from the floor.</p>				

Question #	Criteria (CE = Critical Elements)	Explanation/Guidelines	Yes	No	N/A	Comments
------------	-----------------------------------	------------------------	-----	----	-----	----------

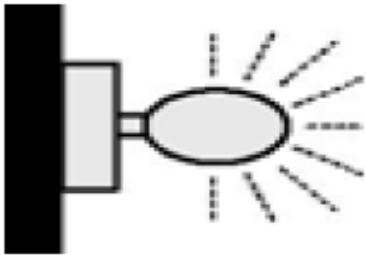
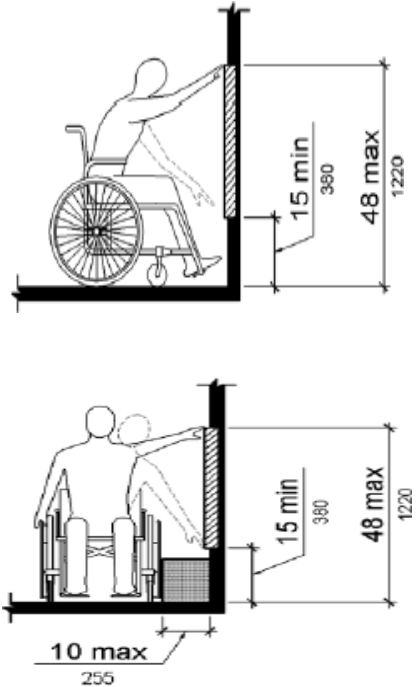
49	<p>If the building has a fire alarm system, are visual signals provided in each public space, including toilet rooms and each room where patients are seen?</p>	<p>If the building does not have a fire alarm system, check NA.</p> 				
50	<p>Are all patient-operated controls (call buttons, self-service literature, brochures, hand sanitizers, etc.) mounted or presented between 15 inches and 48 inches from the floor?</p>					

Question #	Criteria (CE = Critical Elements)	Explanation/Guidelines	Yes	No	N/A	Comments
51	Are all patient operated controls (e.g., call buttons, hand sanitizers) operable with one hand without grasping, pinching, or twisting to operate?	For example, a pump hand sanitizer that must be operated using two hands is inaccessible.				
<b>ELEVATORS</b>						
52	Is there an elevator?					
53 (CE)	<b>If needed, is the elevator available for public/patient use during business hours?</b>	Self explanatory.				

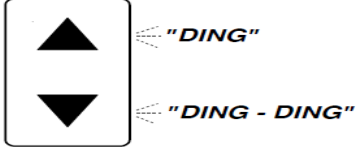
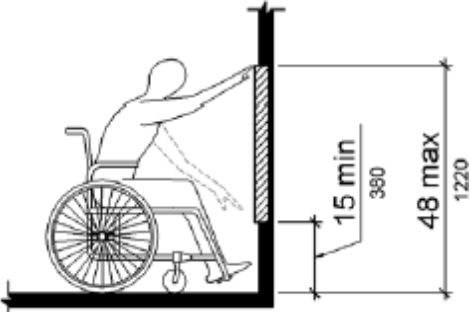
Question #	Criteria (CE = Critical Elements)	Explanation/Guidelines	Yes	No	N/A	Comments
54 (CE)	Is the elevator equipped with both visible and audible door opening/closing and floor indicators?	<p>A visible and audible signal is required at each elevator entrance to indicate which car is answering a call. An audible signal would be a "ding" or a verbal announcement.</p> 				
55 (CE)	Is there a raised letter and Braille sign on each side of each elevator jamb?	<p>These signs allow everyone to know which floor they are on before entering or exiting the elevator.</p>				
56 (CE)	Are the hall call buttons for the elevator no higher than 48 inches from the floor?					

Question #	Criteria (CE = Critical Elements)	Explanation/Guidelines	Yes	No	N/A	Comments
------------	-----------------------------------	------------------------	-----	----	-----	----------

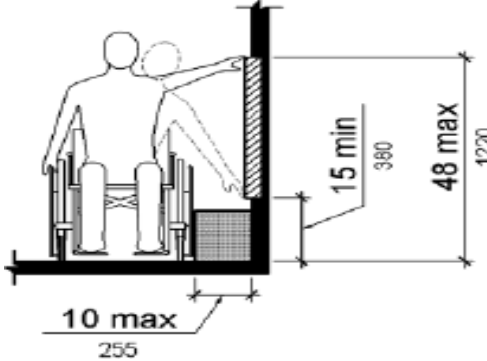
		 <p>The diagram illustrates a person in a wheelchair interacting with a control panel. The wheelchair's reach to the panel is limited to a maximum of 10 inches (255 mm). The control panel's height is specified as a minimum of 15 inches (380 mm) and a maximum of 48 inches (1220 mm).</p>				
--	--	--	--	--	--	--

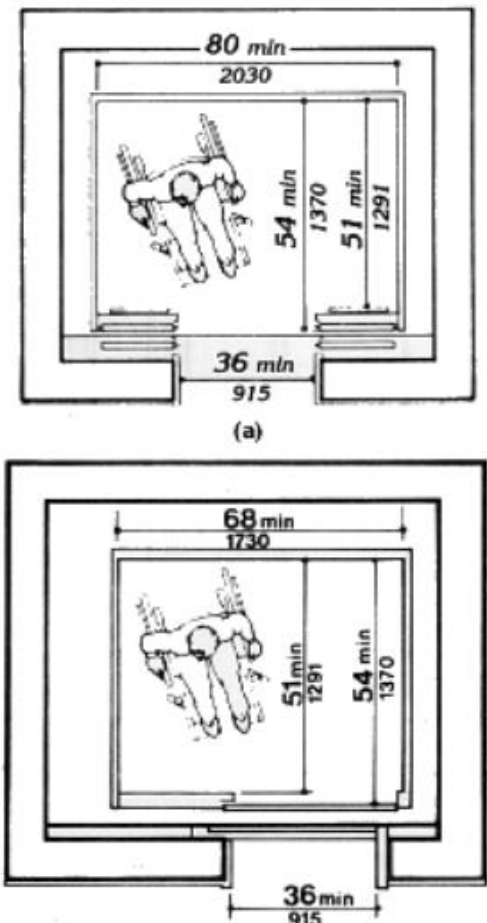

Question #	Criteria (CE = Critical Elements)	Explanation/Guidelines	Yes	No	N/A	Comments
------------	--------------------------------------	------------------------	-----	----	-----	----------

57 (CE)	Is the elevator car large enough for a wheelchair or scooter user to enter, turn to reach the controls, and exit?	<p>The doorway should be at least 36 inches wide and the floor area should be at least 51 inches long and 80 inches wide or 54 inches long and 68 inches wide, depending on where the door is located.</p>  <p>Diagram (a) shows a wheelchair with a 36 min doorway, 54 min length, and 80 min width. Diagram (b) shows a wheelchair with a 36 min doorway, 51 min length, and 68 min width.</p>				
------------	---	---	--	--	--	--

Question #	Criteria (CE = Critical Elements)	Explanation/Guidelines	Yes	No	N/A	Comments
58 (CE)	Do the buttons on the control panel inside the elevator have Braille and raised characters/symbols near the buttons?	Self explanatory.				
59	Is there an emergency communication system in the elevator?	Self explanatory.				
60	Is the elevator emergency communication system usable without requiring voice communication?	It is essential that emergency communication not be dependent on voice communications alone because the safety of people with hearing or speech impairments could be jeopardized. Visible signal requirement could be satisfied with something as simple as a button that lights when the message is answered, indicating that help is on the way.				

Question #	Criteria (CE = Critical Elements)	Explanation/Guidelines	Yes	No	N/A	Comments
------------	-----------------------------------	------------------------	-----	----	-----	----------

61	Do raised letters and Braille identify the emergency intercom in the elevator?	Self explanatory.				
----	--	-------------------	--	--	--	--

**TOILET ROOMS (INCLUDING THOSE USED FOR SPECIMEN COLLECTION)**

**ALL TOILET ROOMS:**

62	Is there an accessible toilet room?	Self explanatory.				
----	-------------------------------------	-------------------	--	--	--	--

63	If there is an inaccessible toilet room, is there directional signage to an accessible toilet room?	Mark NA if there are no inaccessible toilet rooms. Self explanatory.				
----	---	---	--	--	--	--

64	Does the interior door to the restroom require less than 5 pounds of pressure to open?	If restroom door is a fire door, check NA. For interior doors (not fire doors), labor force to open a door should be ≤ 5 lbs. Measure the				
----	--	--	--	--	--	--

Question #	Criteria (CE = Critical Elements)	Explanation/Guidelines	Yes	No	N/A	Comments
------------	-----------------------------------	------------------------	-----	----	-----	----------

		weight of the labor force of the door after the door is unlatched; attach the hook end of the scale to the door handle and pull until the door opens and read the weight of the force.				
--	--	--	--	--	--	--

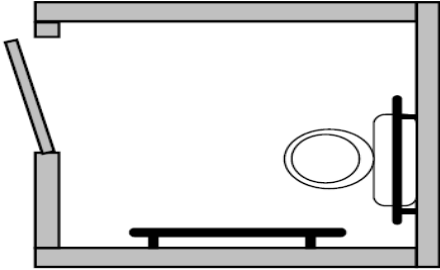
65 (CE)	<p><b>For all toilet rooms with and without stalls:</b></p> <p><b>Are grab bars provided, one on the wall behind the toilet and one on the wall next to the toilet?</b></p>	<p>Grab bars should be installed in a horizontal position between 33 and 36 inches above the floor measured to the top of the gripping surface.</p> 				
---------	---	--	--	--	--	--

66	Are all objects mounted at least 12 inches above and 1½ inches below the grab bars?	This includes seat cover dispensers, toilet paper dispensers, sanitizers, trash containers, etc.				
----	---	--	--	--	--	--

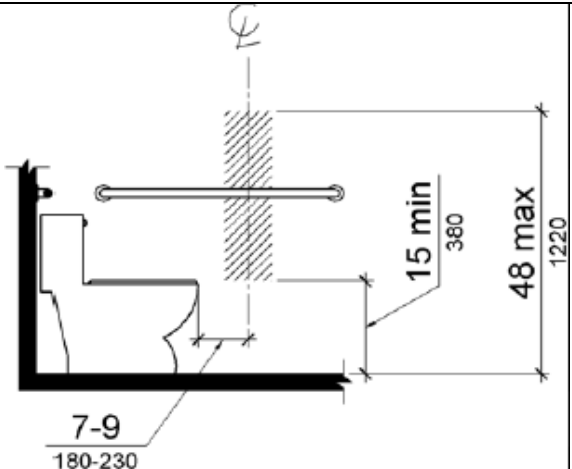
67 (CE)	<p><b>Is the toilet paper dispenser mounted below the side grab bar with the centerline of the toilet paper dispenser between 7 inches and 9 inches in front of the toilet, and at least 15 inches high?</b></p>					
---------	--	---	--	--	--	--

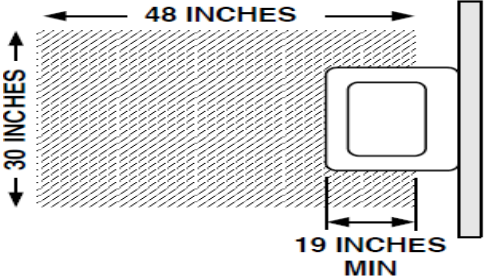
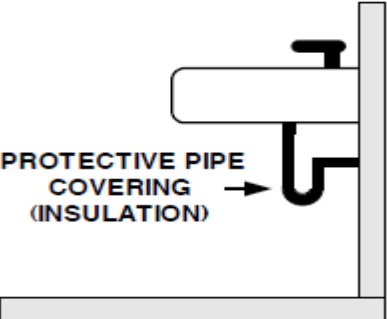
Question #	Criteria (CE = Critical Elements)	Explanation/Guidelines	Yes	No	N/A	Comments
68 (CE)	Is there a space that is at least 30 inches wide and 48 inches deep to allow wheelchair users to park in front of the sink?	<p>This space must extend at least 17 inches under the sink from the front edge, although it can extend up to 19 inches underneath.</p> 				
69	Is the space in front of the sink free of trash cans and other movable items?	Self explanatory.				
70	Are the pipes and water supply lines under the sink wrapped with a protective cover?					
71 (CE)	Are faucet handles operable with one hand and without grasping, pinching, or twisting? (Check Yes if faucets are automatic.)	A knob handle would not be accessible.				

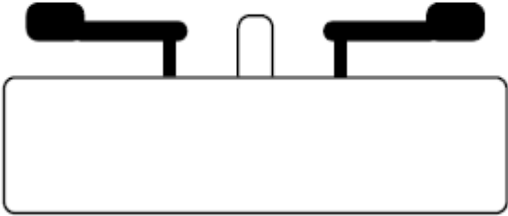
Question #	Criteria (CE = Critical Elements)	Explanation/Guidelines	Yes	No	N/A	Comments
		<p style="text-align: center;"><b>LEVER HANDLES</b></p> 				
72	Are all dispensers mounted no higher than 40 inches from the floor?	Included are soap dispensers, paper towel dispensers, seat cover dispensers, hand dryers, etc.				
73	Are all dispensers (soap, paper towel, etc.) operable with one hand and without grasping, pinching, or twisting?	Self explanatory.				
74	If there is a pass-through door for specimen collection, is there a 30 inches by 48 inches space for a wheelchair or scooter user to park in front of it?	If there is no such door, check NA.				

Question #	Criteria (CE = Critical Elements)	Explanation/Guidelines	Yes	No	N/A	Comments
------------	--------------------------------------	------------------------	-----	----	-----	----------

**TOILET ROOM WITHOUT STALLS**

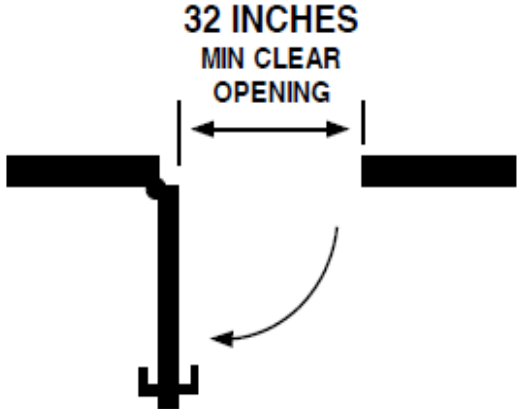
75 (CE)	<p><i>Toilet room without stalls:</i></p> <p>Do toilet room doorways have a minimum clear opening of 32 inches with the door open at 90 degrees, measured between the face of the door and the opposite stop?</p>	<p>If there is no toilet room without stalls, check NA.</p>  <p>The diagram illustrates a door in an open position. A horizontal double-headed arrow above the door indicates the clear opening, labeled '32 INCHES MIN CLEAR OPENING'. A curved arrow points to the door, indicating it is open at 90 degrees. The door is shown as a thick black line, and the stop is a small vertical line on the opposite side of the doorway.</p>				
76	<p>Is the space inside the toilet room without stalls clear, without trash cans, shelves, equipment, chairs, and other movable objects?</p>	<p>Self explanatory.</p>				

Question #	Criteria (CE = Critical Elements)	Explanation/Guidelines	Yes	No	N/A	Comments
------------	--------------------------------------	------------------------	-----	----	-----	----------

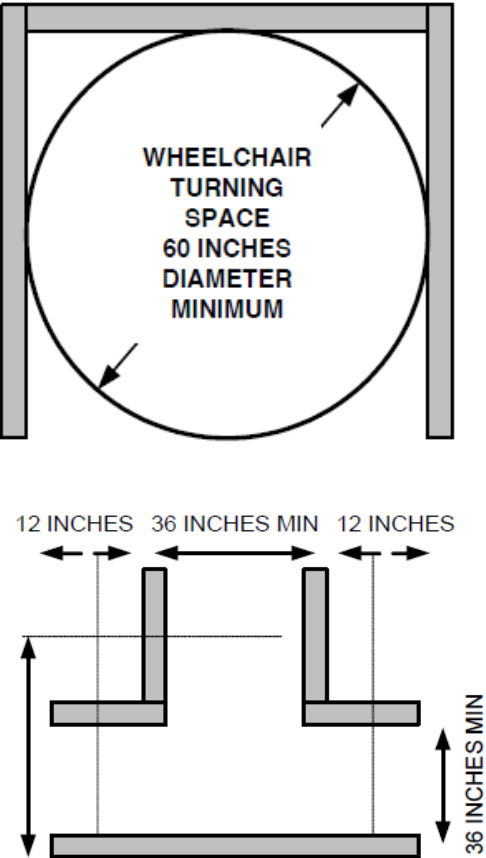
TOILET ROOM WITH STALLS						
77 (CE)	<p><i>Toilet Room with stalls:</i></p> <p>Is there a 60-inch diameter turning circle or a 60 inch x 60 inch "T"-shaped space inside the toilet room with stalls to allow a turn around for wheelchair and scooter users?</p>	<p>If there is no toilet room with stalls, check NA.</p>  <p>The diagram consists of two parts. The top part shows a square frame with a circle inside. The circle is labeled 'WHEELCHAIR TURNING SPACE 60 INCHES DIAMETER MINIMUM'. The bottom part shows a T-shaped space between two stalls. The horizontal distance between the centerlines of the two stalls is labeled '36 INCHES MIN'. There are '12 INCHES' of clear space on either side of this central area. The vertical distance from the top of the stalls to the bottom of the T-shaped space is labeled '60 INCHES MIN'. The vertical distance from the bottom of the stalls to the bottom of the T-shaped space is labeled '36 INCHES MIN'.</p>				

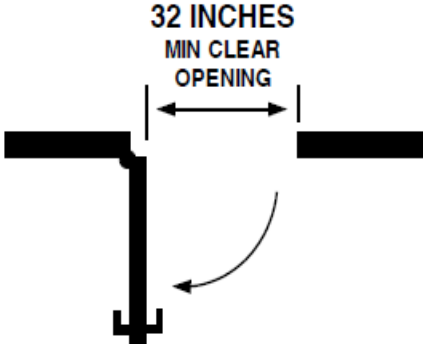

Question #	Criteria (CE = Critical Elements)	Explanation/Guidelines	Yes	No	N/A	Comments
78	Is the space inside the accessible stall clear, without trash cans, shelves, equipment, chairs, and other movable objects?	Self explanatory.				
79	Can the hardware on the stall door be operated without grasping, pinching, or twisting of the wrist?	Handles, pulls, latches, locks, and other operating devices on accessible doors shall have a shape that is easy to grasp with one hand and does not require tight grasping, tight pinching, or twisting of the wrist to operate.				
<b>EXAM/TREATMENT ROOMS/MEDICAL EQUIPMENT</b>						
80 (CE)	Do exam room doorways have a minimum clear opening of 32 inches with the door open at 90 degrees, measured between the face of the door and the opposite stop?	 <p>The diagram illustrates a door in an open position. A horizontal double-headed arrow indicates the clear opening between the door's face and the opposite stop, labeled '32 INCHES MIN CLEAR OPENING'. A curved arrow points to the door's edge, indicating its 90-degree opening.</p>				

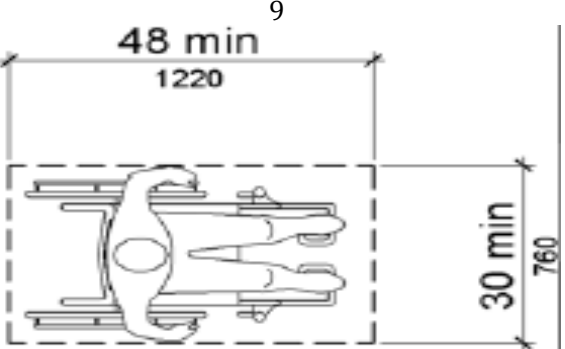
Question #	Criteria (CE = Critical Elements)	Explanation/Guidelines	Yes	No	N/A	Comments
81 (ME)	Is there a height adjustable exam table that lowers to between 17 inches and 19 inches from the floor to the top of the cushion?	Self explanatory				
82 (ME)	Is there space next to the height adjustable exam table for a wheelchair or scooter user to approach, park, and transfer or be assisted to transfer onto the table?	 <p>The diagram illustrates a wheelchair positioned next to a table. A dashed rectangular box indicates the required clear space. The width of the wheelchair is labeled as 48 min. The length of the wheelchair is 1220. The clear space next to the wheelchair is 30 min. The total length of the wheelchair and clear space is 760.</p>				
83	Does the exam table provide elements to assist during a transfer (such as rails) and support a person while on the table? (If yes, please list in comments.)	Items that could help support a patient while on the table would be armrests, side rails, padded straps, cushions, wedges, etc.				

Question #	Criteria (CE = Critical Elements)	Explanation/Guidelines	Yes	No	N/A	Comments
------------	-----------------------------------	------------------------	-----	----	-----	----------

84	Is a lift available to assist staff with transfers (portable, overhead, or ceiling mounted)?	Self explanatory.				
----	--	-------------------	--	--	--	--

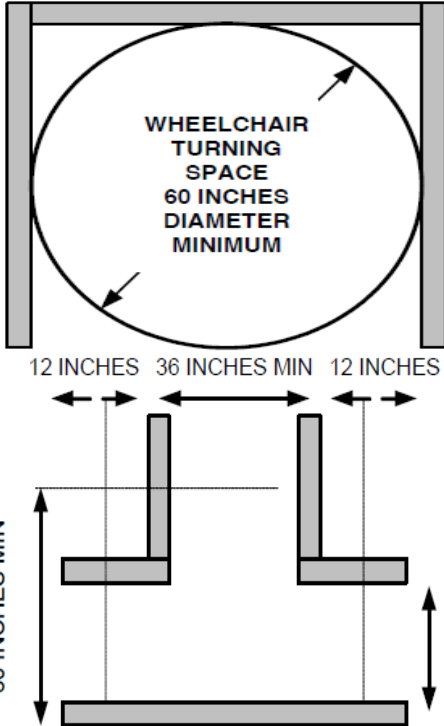
85 (CE)	Is there a 60 inch diameter turning circle or a 60 inch x 60 inch "T"-shaped space so that a wheelchair or scooter user can make a 180° turn?	 <p style="text-align: center;">WHEELCHAIR TURNING SPACE 60 INCHES DIAMETER MINIMUM</p> <p style="text-align: center;">12 INCHES 36 INCHES MIN 12 INCHES</p> <p style="text-align: center;">60 INCHES MIN 36 INCHES MIN</p>				
---------	---	--	--	--	--	--

Question #	Criteria (CE = Critical Elements)	Explanation/Guidelines	Yes	No	N/A	Comments
86 (ME)	<b>Is a weight scale available within the medical office with a platform to accommodate a wheelchair or scooter and the patient?</b>	Accessible scales are usable by all people including: wheelchair users, people with activity limitations, and larger people who may exceed a standard weight scale limit. This includes people with conditions that interfere with mobility, walking, climbing, using steps (joint pain, short stature, pregnancy, fatigue, respiratory and cardiac conditions, post surgical conditions, orthopedic injuries); and/or who use mobility devices (e.g. canes, crutches, walkers).				

## References

### *2010 ADA Standards for Accessible Design*

U.S Department of Justice

[http://www.ada.gov/2010ADASTandards\\_index.htm](http://www.ada.gov/2010ADASTandards_index.htm)

The revised regulations for Titles II and III of the Americans with Disabilities Act of 1990 (ADA) were published in the Federal Register on September 15, 2010. They provide the scoping and technical requirements for new construction and alterations resulting from the adoption of revised 2010 Standards in the final rules for Title II (28 CFR part 35) and Title III (28 CFR part 36). The 2010 ADA Standards go into effect March 15, 2012, but can be used now instead of the 1991 standards. The FSR Attachment C draws upon access requirements found in both the 1991 Americans with Disabilities Act Accessibility Guidelines and the 2010 ADA Standards. Some diagrams that appear in the FSR Attachment C are reproduced from these sources.

Two questions in the FSR Attachment C were drawn from Title 24, Part 2 of the California Building Standards Code. These are

1133B.4.4 – Striping for the visually impaired (Rev.1-1-2009), and 1115B-1 – Bathing and Toilet Facilities, placement of toilet paper dispensers. These standards can be found in:

***2009 California Building Standards Code with California Errata and Amendments***

State of California

Department of General Services

Division of the State Architect

Updated April 27, 2010

[http://www.documents.dgs.ca.gov/dsa/pubs/access\\_manual\\_rev\\_04-27-10.pdf](http://www.documents.dgs.ca.gov/dsa/pubs/access_manual_rev_04-27-10.pdf)

Some diagrams are reprinted with permission from the Kentucky Department of Vocational Rehabilitation. These illustrations can also be found in:

**“Health Care Usability Profile V3”**

© Copyright 2008

Oregon Health & Science University RRTC: Health & Wellness

Authors: Drum, C.E., Davis, C.E., Berardinelli, M., Cline, A., Laing, R., Horner-Johnson, W., & Krahn, G.

Oregon Institute on Disability and Development

Portland, OR 97239

[rrtc@ohsu.edu](mailto:rrtc@ohsu.edu)

[healthwellness.org](http://healthwellness.org)