

Community Based Adult Services (CBAS) Physical Accessibility Review Survey

California Department of Health Care Services
Managed Care Quality and Monitoring Division

Provider Name: <input type="checkbox"/> CBAS <input type="checkbox"/> Other	Date of Review:
	Name of Reviewer:
Address:	Health Plan Name:
City:	
Phone: FAX:	Contact Person Name:
	<i>Level of Access:</i>
<i>Basic Access:</i> Demonstrates facility site access for the members with disabilities to parking, building, elevator, Participant Areas, and restroom. To meet Basic Access requirements, all (24) Critical Elements (CE) must be met.	<input type="checkbox"/> Basic Access
<i>Limited Access:</i> Demonstrates facility site access for the members with a disability is missing or is incomplete in one or more features for parking, building, elevator, participant areas, and restroom. Deficiencies in 1 or more of the Critical Elements (CE) are encountered.	<input type="checkbox"/> Limited Access

Below are the symbols that will be used in the provider directories to indicate areas of accessibility at a provider office/site. These should also be used in online directories. In order for a provider office to receive a symbol, the appropriate criteria must be met.

These symbols are in addition to identifying whether the provider office has Basic Access or Limited Access. A provider who has Basic Access will automatically meet the critical elements for the first six symbols (P, EB, IB, R, PA,). And a provider who has Medical Equipment Access will meet the medical equipment elements for the last symbol (T).

Accessibility Indicator	Must Satisfy these Criteria	Yes	No	N/A	Comments
P = PARKING	Critical Elements (CE): 6,7,8				
EB = EXTERIOR BUILDING	(CE): 9,15,16,17,20				
IB = INTERIOR BUILDING	(CE): 23,26,36,37,38,39,40,41				
R=RESTROOM	(CE): 47,49,50,53,56,58				
PA= PARTICIPANT AREAS	(CE): 60,61				

2nd Periodic PARS Review: I certify that there have been no changes since the last physical accessibility review:

Name: _____ Signature: _____ Date: _____

3rd Periodic PARS Review: I certify that there have been no changes since the last physical accessibility review:

Name: _____ Signature: _____ Date: _____

PARKING						
1	Are accessible parking spaces provided in the designated parking area?	Self explanatory.				
2	Are the correct number of accessible parking spaces provided? 1 to 25 total spaces – 1 required 26 to 50 – 2 required 51 to 75 – 3 required 76 to 100 – 4 required 101 to 150 – 5 required 151 to 200 – 6 required 201 to 300 – 7 required 301 to 400 – 8 required	If there are 25 total parking spaces or less, at least one accessible space is required. If there are between 26 and 50 total spaces, at least two accessible spaces are required, etc.				
3	Is the accessible parking space(s) closest to the main entrance?	The accessible parking space (s) should afford the shortest route of travel from adjacent parking to the accessible entrance.				

4	Does every accessible parking space have a vertical sign posted with the International Symbol of Accessibility?	<p>Symbol in the illustration depicts the International Symbol of Accessibility.</p> 				
5	Are signs mounted a minimum of 60 inches above the ground surface so that they can be seen over a parked vehicle?	Signs must be located so a vehicle parked in the space does not obscure them. (Van accessible spaces must be indicated with an additional sign)				

6 (CE)	Is a passenger loading zone provided with a vehicular pull-up space.	The vehicular pull-up space dimension is a minimum of 96 inches wide and 20 feet long				
-----------	-----------------------------------------------------------------------------	---------------------------------------------------------------------------------------	--	--	--	--

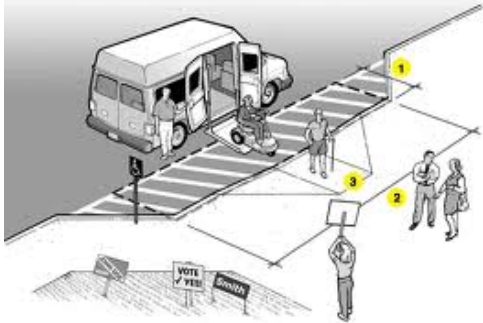
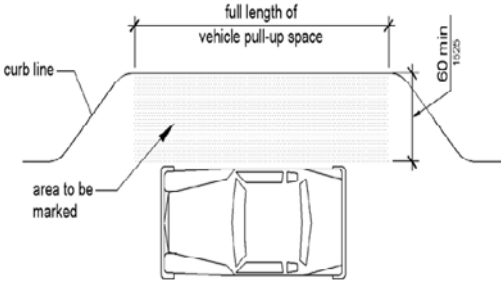
<p>7 (CE)</p>	<p>Is there an access aisle that adjoins an accessible route and does not overlap the Vehicular way /driveway?</p>	<p>Access aisles serving vehicle pull-up spaces shall be a minimum of 60 inches wide.</p>  				
<p>8 (CE)</p>	<p>Do curbs on the route have curb ramps at the drop off locations?</p>	<p>Pathways should have curb ramps. Without curb ramps, wheelchair users may be required to travel in the street or behind parked cars where drivers cannot see them.</p>				

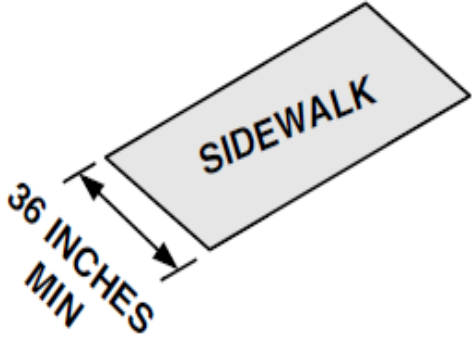
EXTERIOR ROUTE (FROM DROP OFF AND PICK UP LOCATIONS TO THE ENTRANCE)					
9 (CE)	For exterior routes, if the accessible route crosses a curb, is a curb ramp provided to the building entrance from the following: (Please mark NA for those that do not apply.)	Self explanatory.			
	a. Public Transportation				
	b. Public sidewalk?				
	c. Drop off?				
10	Is the accessible route to the building entrance at least 36 inches wide for exterior routes from the following: (Please mark NA for those that do not apply.)				
	a. Public Transportation				
	b. Public sidewalk?				
	c. Drop off?				
11	Is the accessible route to the	An example of a stable surface is a floor or			

	building entrance stable, firm, and slip resistant from the following: (Please mark NA for those that do not apply.)	ground surface without loose elements like gravel or wood chips. Firm surfaces include solid concrete or pavement as opposed to a grassy, graveled or soft soil surface. Avoid glossy or slick surfaces such as ceramic tile.				
	a. Public Transportation					
	b. Public sidewalk?					
	c. Drop off?					
12	Is there an accessible route that does not include stairs or steps?	Self explanatory.				
13	Is the route to the entrance from drop off, free of grates, gaps, and openings that are both greater than ½ inch wide and over ¼ inch deep?	Self explanatory.				

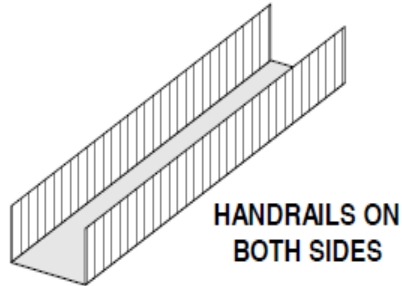
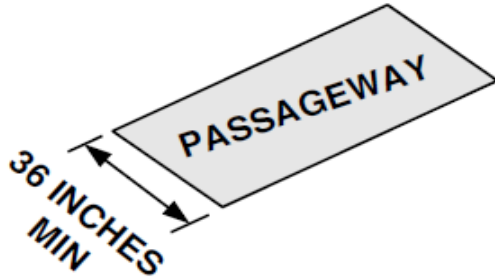
RAMPS:						
14	Is an access ramp present?	If there is more than one ramp, select the one that appears to be the primary access ramp.				
15 (CE)	Are handrails provided on both sides of the ramp that are mounted between 34 and 38 inches above the ramp surface, if it is longer than 6 feet?	<p>If the ramp is not longer than 6 feet, check N/A.</p> 				
16 (CE)	Are all ramps at least 36 inches wide?					

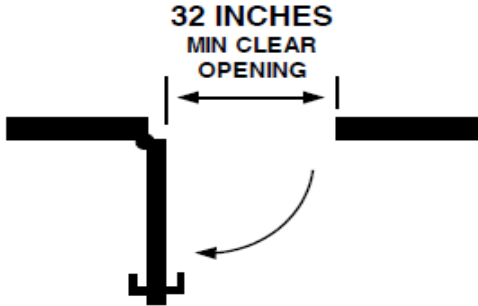
BUILDING ENTRANCE						
	Is the main entrance accessible?	Self explanatory.				
18	If a main entrance is not accessible, is there another accessible entrance?	Self explanatory.				
19	If a main entrance is not accessible, is there directional signage indicating the location of the accessible entrance?					
	Do doors have an opening at least 32 inches wide (at the narrowest point below the opening hardware) when opened to 90°?	<p>When measuring double doors, measure the opening with one door open to 90°.</p> 				

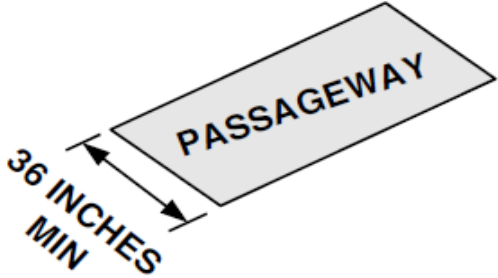
21	Are there automatic doors?	Self explanatory.				
INTERIOR ROUTE (FROM THE BUILDING ENTRANCE, TO THE REGISTRATION COUNTER/WINDOW, AND THROUGH TO THE PARTICIPANT AREAS						
22	Is there an interior route to the participant area?	Some participant areas are accessed directly from the street or drop off rather than being located within a larger building or complex, therefore they do not have interior routes.				
23 (CE)	Are <u>ALL</u> interior paths of travel at least 36 inches wide?					
24	Is the interior accessible route stable, firm, and slip resistant?	<p>Avoid unsecured carpeting or other loose elements.</p> <p>It is easier for people using walkers, wheelchairs and other aids to walk or push on surfaces that have low pile carpeting without a pad underneath.</p> <p>Glossy or slick surfaces such as ceramic tile or marble can be slippery.</p>				

25	Is the interior accessible route well lighted?	A brightly lit corridor will help avoid falls.				
26 (CE)	If there are stairs on the accessible route, are there handrails on each side?	If there are no stairs, check N/A.				
27	If there are stairs, are all stair risers closed that are on the accessible route?					
28	If there are stairs, are all stair treads marked by a stripe providing a clear visual contrast to assist people with visual impairments?	Contrast striping must be provided on the upper approach and lower tread for interior stairs and on the upper approach and all treads for exterior stairs. Stripes must be 2" to 4" wide placed parallel to and no more than 1" from the nose of the step or upper approach. The stripe must extend the full width of the step or upper approach and should be made of material that is at least as slip resistant as the other stair treads (a painted stripe is acceptable).				

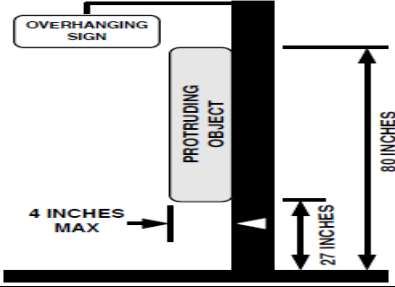
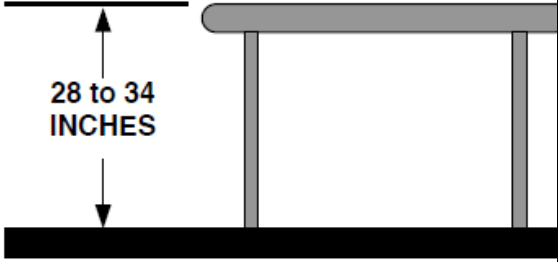
<p>29</p>	<p>Is the path through the facility free of any objects that stick out into the circulation path that a blind person might not detect with a cane?</p>	<p>If an object protrudes more than 4 inches and is located between 27 inches above the walking surface and below 80 inches, a blind person walking with a cane will not detect it.</p>  <p>The diagram illustrates a vertical wall with a rectangular object protruding from it. The object is labeled 'PROTRUDING OBJECT'. A horizontal line above the object is labeled 'OVERHANGING SIGN'. Dimension lines indicate that the object's width is '4 INCHES MAX', its height from the floor is '27 INCHES', and the total height from the floor to the top of the object is '80 INCHES'.</p>				
<p>30</p>	<p>If floor mats are used, are the edges of floor mats stiff enough or secured so that they do not roll up?</p>	<p>If floor mats are not in use, check NA. Floor mats that are not secured to the floor can roll up or bunch up under walkers or wheelchair casters and cause a tripping hazard.</p>				
<p>31</p>	<p>Is a section of the sign-in/registration counter no more than 34 inches high and at least 36 inches wide and free of stored items.</p>	 <p>The diagram shows a cross-section of a counter. A vertical double-headed arrow indicates the height from the floor to the top surface of the counter, labeled '28 to 34 INCHES'.</p>				

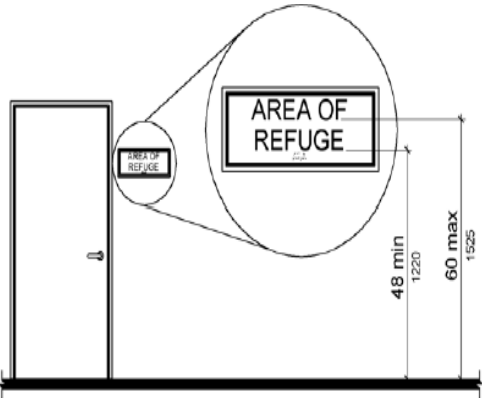
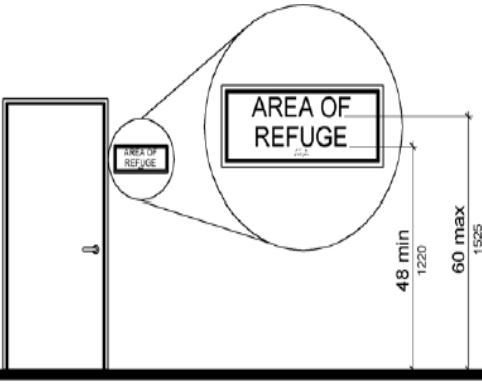
<p>32</p>	<p>Do signs identifying permanent rooms and spaces include raised letters and Braille?</p>					
<p>33</p>	<p>Are the raised letters and Braille signs mounted between 48 inches and 60 inches from the floor?</p>	 <p>Raised letters and Braille signs are either on the latch side of doors or on the face of doors and are mounted between 48 inches and 60 inches from the floor.</p>				

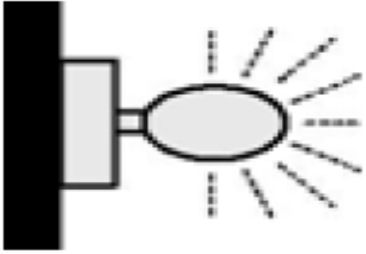
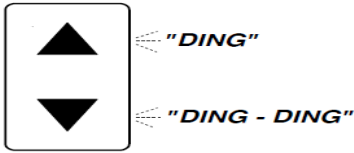
34	If the building has a fire alarm system, are visual signals provided in each public space, including toilet rooms and Participant Areas?	<p>If the building does not have a fire alarm system, check NA.</p> 				
ELEVATORS						
35	Is there an elevator?					
36 (CE)	If needed, is the elevator available for public/patient use during business hours?	Self explanatory.				
37 (CE)	Is the elevator equipped with both visible and audible door opening/closing and floor indicators?	<p>A visible and audible signal is required at each elevator entrance to indicate which car is answering a call. An audible signal would be a "ding" or a verbal announcement.</p> 				

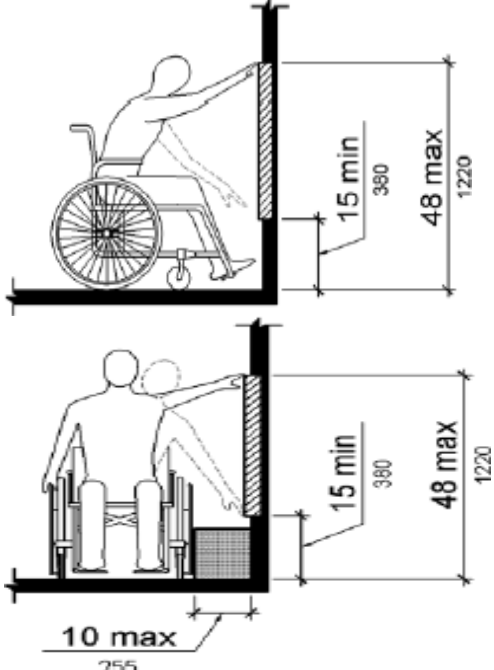
38 (CE)	Are there raised letter and Braille sign on each side of each elevator jamb?	These signs allow everyone to know which floor they are on before entering or exiting the elevator.				
39 (CE)	Are the hall call buttons for the elevator no higher than 48 inches from the floor?	 <p>The diagrams illustrate the height requirements for elevator call buttons. The top diagram shows a person in a wheelchair reaching for a button, with dimensions: 15 min (380) and 48 max (1220). The bottom diagram shows a person in a wheelchair reaching for a button, with dimensions: 15 min (380), 48 max (1220), and 10 max (255).</p>				

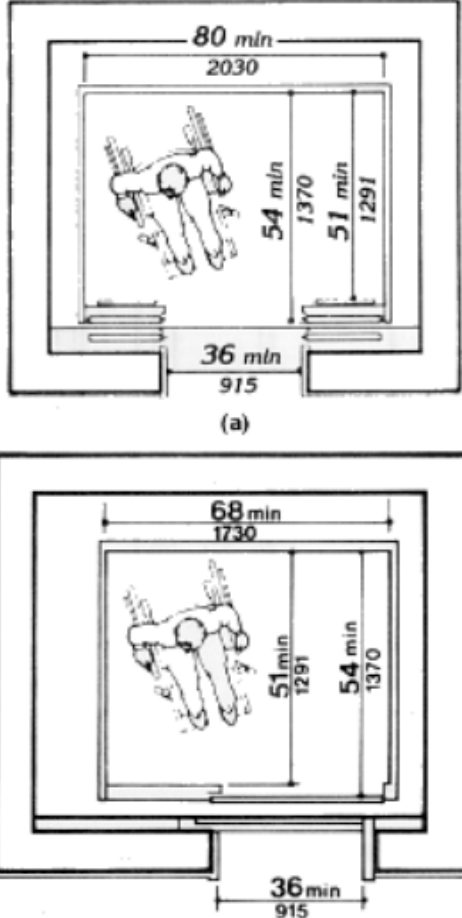
<p>40 (CE)</p>	<p>Is the elevator car large enough for a wheelchair or scooter user to enter, turn to reach the controls, and exit?</p>	<p>The doorway should be at least 36 inches wide and the floor area should be at least 51 inches long and 80 inches wide or 54 inches long and 68 inches wide, depending on where the door is located.</p>  <p>(a)</p>				
<p>41 (CE)</p>	<p>Do the buttons on the control panel inside the elevator have Braille and raised characters/symbols near the buttons?</p>	<p>Self explanatory.</p>				

42	Is there an emergency communication system in the elevator?	Self explanatory.				
43	Is the elevator emergency communication system usable without requiring voice communication?	It is essential that emergency communication not be dependent on voice communications alone because the safety of people with hearing or speech impairments could be jeopardized. Visible signal requirement could be satisfied with something as simple as a button that lights when the message is answered, indicating that help is on the way.				
44	Do raised letters and Braille identify the emergency intercom in the elevator?	Self explanatory.				

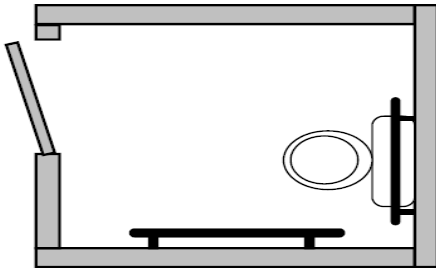
ALL RESTROOMS/TOILET ROOMS (WITH AND WITHOUT STALLS):						
45	Is there an accessible restroom/toilet room?	Self explanatory.				
46	Does the interior door to the restroom require less than 5 pounds of pressure to open?	<p>If restroom door is a fire door, check NA.</p> <p>For interior doors (not fire doors), labor force to open a door should be ≤ 5 lbs. Measure the weight of the labor force of the door after the door is unlatched; attach the hook end of the scale to the door handle and pull until the door opens and read the weight of the force.</p>				
47 (CE)	Are grab bars provided, one on the wall behind the toilet and one on the wall next to the toilet?	<p>Grab bars should be installed in a horizontal position between 33 and 36 inches above the floor measured to the top of the gripping surface.</p> 				
48	Are all objects mounted at least 12 inches above and/or 1½ inches below the grab bars?	This includes seat cover dispensers, toilet paper dispensers, sanitizers, trash containers, etc.				

<p>49 (CE)</p>	<p>Is the toilet paper dispenser mounted below the side grab bar with the centerline of the toilet paper dispenser between 7 inches and 9 inches in front of the toilet, and at least 15 inches high?</p>					
<p>50 (CE)</p>	<p>Is there a space that is at least 30 inches wide and 48 inches deep to allow wheelchair users to park in front of the sink?</p>	<p>This space must extend at least 17 inches under the sink from the front edge, although it can extend up to 19 inches underneath.</p>				
<p>51</p>	<p>Is the space in front of the sink free of trashcans and other movable items?</p>	<p>Self explanatory.</p>				

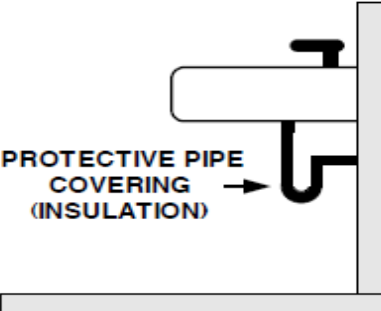
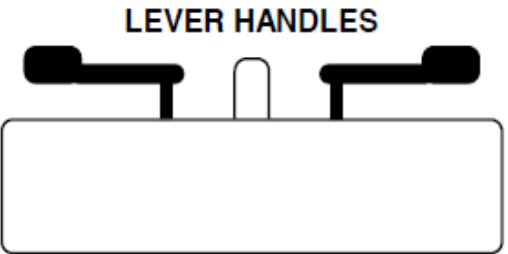
52	Are the pipes and water supply lines under the sink wrapped with a protective cover?	 <p>PROTECTIVE PIPE COVERING (INSULATION)</p>				
53 (CE)	Are faucet handles operable with one hand and without grasping, pinching, or twisting? (Check Yes if faucets are automatic.)	<p>A knob handle would not be accessible.</p>  <p>LEVER HANDLES</p>				
54	Are all dispensers mounted no higher than 40 inches from the floor?	Included are soap dispensers, paper towel dispensers, seat cover dispensers, hand dryers, etc.				
55	Are all dispensers (soap, paper towel, etc.) operable with one hand and without grasping, pinching, or twisting?	Self explanatory.				

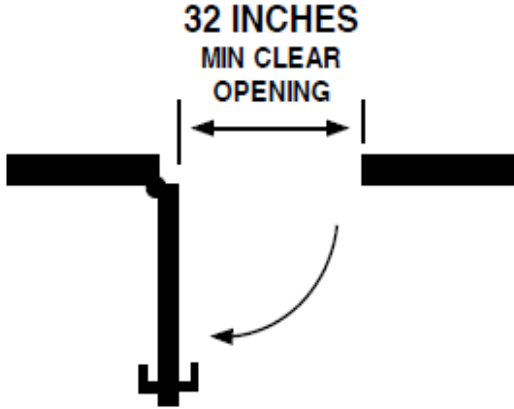
56 (CE)	Do restroom doorways have a minimum clear opening of 32 inches with the door open at 90 degrees, measured between the face of the door and the opposite stop?	 <p style="text-align: center;">32 INCHES MIN CLEAR OPENING</p>				
57	Is the space inside the restroom clear, without trashcans, shelves, equipment, chairs, and other movable objects?	Self explanatory.				

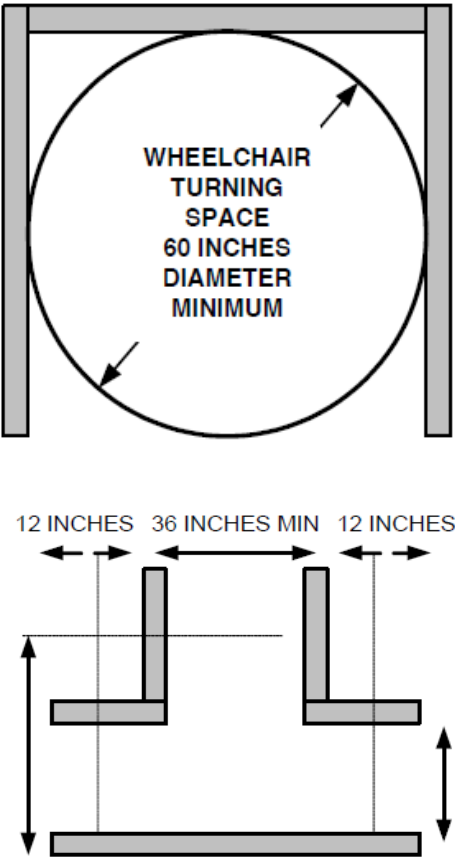
<p>58 (CE)</p>	<p>Is there a 60-inch diameter turning circle or a 60 inch x 60 inch "T"-shaped space inside the restroom to allow a turn around for wheelchair and scooter users?</p>	 <p>The diagram consists of two parts. The top part shows a circle with a diameter of 60 inches, labeled 'WHEELCHAIR TURNING SPACE 60 INCHES DIAMETER MINIMUM', situated within a rectangular frame. The bottom part shows a T-shaped space with dimensions: a central horizontal bar of 36 inches minimum, flanked by two vertical bars of 12 inches each, and a vertical bar of 60 inches minimum on the left and 36 inches minimum on the right.</p>				
<p>59</p>	<p>Can the hardware on the stall door be operated without grasping, pinching, or twisting of the wrist?</p>	<p>Handles, pulls, latches, locks, and other operating devices on accessible doors shall have a shape that is easy to grasp with one hand and does not require tight grasping, tight pinching, or twisting of the wrist to operate.</p>				

PARTICIPANT AREAS (QUIET ROOM/THERAPY ROOM S-PT/OT, ACTIVITY AREA)

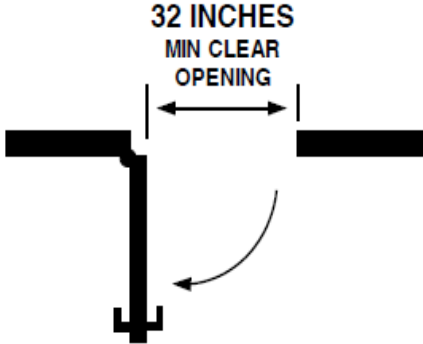
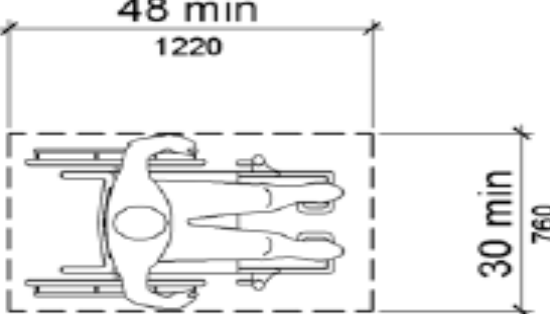
<p>60 (CE)</p>	<p>Do doorways have a minimum clear opening of 32 inches with the door open at 90 degrees, measured between the face of the door and the opposite stop?</p>	 <p>32 INCHES MIN CLEAR OPENING</p>				
<p>61 (CE)</p>	<p>There is space in the following areas for a wheelchair or scooter user to approach and park for participation in activities or use of exercise equipment:</p>	 <p>48 min 1220 30 min 760</p>				
	<p>a. Quiet room?</p>					
	<p>b. Physical Therapy Room {PT}?</p>					
	<p>c. Occupational Therapy {OT}?</p>					
	<p>d. Activity Area</p>					

62	Is there a bed that is between 17 inches and 19 inches from the floor to the top of the cushion?	Self explanatory				
----	--------------------------------------------------------------------------------------------------	------------------	--	--	--	--